

March 24, 1931.

W. GATERMAN

1,797,682

GRAIN LIFTER GUARD FOR MOWING MACHINES

Filed June 12, 1929

2 Sheets-Sheet 1

Fig. 1.

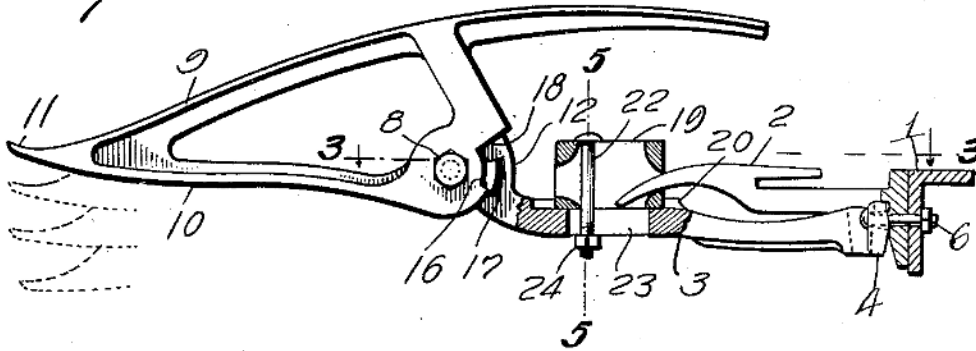

Fig. 2.

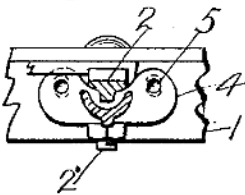

Fig. 3.

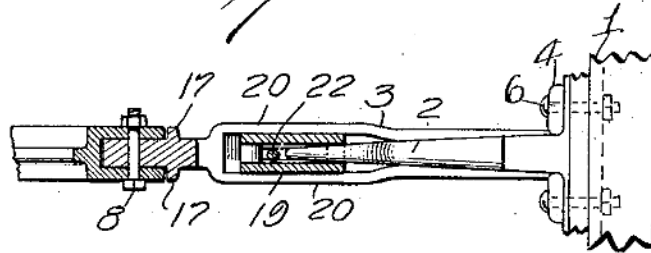

Fig. 4.

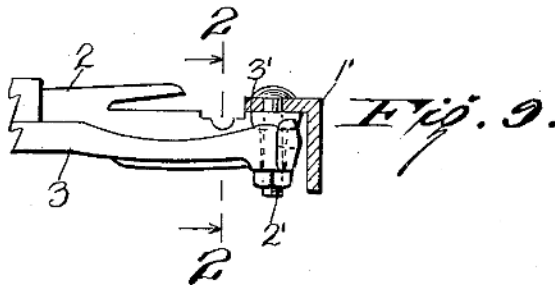
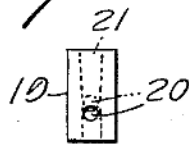
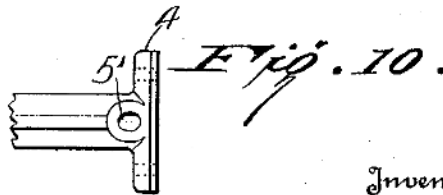
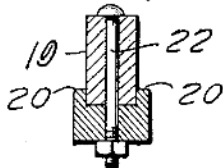

Fig. 5.



Inventor

W. GATERMAN,

By

Attorneys